



SGM8965A-2Q

50MHz, Low Distortion, Rail-to-Rail I/O, Single-Supply, Automotive Operational Amplifier

GENERAL DESCRIPTION

The SGM8965A-2Q is a dual, high speed CMOS operational amplifier with high input impedance, zero-crossover and low distortion. This device can operate from 2.2V to 5.5V single supply.

The SGM8965A-2Q features high speed and low noise. It supports rail-to-rail input and output operation. The input common mode voltage range is from $(-V_S) - 0.1V$ to $(+V_S) + 0.1V$, and the output range is from $(-V_S) + 0.006V$ to $(+V_S) - 0.006V$. Furthermore, the SGM8965A-2Q provides high CMRR with zero-crossover and low distortion, which is designed to drive ADCs with high linearity. The device can be used in a variety of applications, such as audio, mobile phone and signal conditioning.

The SGM8965A-2Q is available in Green SOIC-8 and MSOP-8 packages. It is specified over the extended $-40^{\circ}C$ to $+125^{\circ}C$ temperature range.

This device is AEC-Q100 qualified (Automotive Electronics Council (AEC) standard Q100 Grade 1) and it is suitable for automotive applications.

FEATURES

- **AEC-Q100 Qualified for Automotive Applications Device Temperature Grade 1**
 $T_A = -40^{\circ}C$ to $+125^{\circ}C$
- **Unity-Gain Stable**
- **Gain-Bandwidth Product: 50MHz**
- **Slew Rate: 28V/ μ s**
- **High CMRR: 94dB (TYP)**
- **Low Offset Voltage: 280 μ V (MAX)**
- **Low Bias Current: 1pA (TYP)**
- **Low Input Voltage Noise: 5.5nV/ \sqrt{Hz} at 100kHz**
- **Rail-to-Rail Input and Output**
- **Supply Voltage Range: 2.2V to 5.5V**
- **Available in Green SOIC-8 and MSOP-8 Packages**

APPLICATIONS

AEC-Q100 Grade 1 Application
Audio Processing
Active Filter
Signal Conditioning
Sensor Amplification
Data-Acquisition System
Process Control
Test Equipment
Wideband Amplifier

50MHz, Low Distortion, Rail-to-Rail I/O, SGM8965A-2Q Single-Supply, Automotive Operational Amplifier

PACKAGE/ORDERING INFORMATION

MODEL	PACKAGE DESCRIPTION	SPECIFIED TEMPERATURE RANGE	ORDERING NUMBER	PACKAGE TOP MARKING	PACKING OPTION
SGM8965A-2Q	SOIC-8	-40°C to +125°C	SGM8965A-2QS8G/TR	0ANS8 XXXXX	Tape and Reel, 4000
	MSOP-8	-40°C to +125°C	SGM8965A-2QMS8G/TR	0AMMS8 XXXXX	Tape and Reel, 4000

MARKING INFORMATION

NOTE: XXXXX = Date Code, Trace Code and Vendor Code.

XXXXX

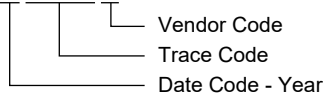

Green (RoHS & HSF): SG Micro Corp defines "Green" to mean Pb-Free (RoHS compatible) and free of halogen substances. If you have additional comments or questions, please contact your SGMICRO representative directly.

ABSOLUTE MAXIMUM RATINGS

Supply Voltage.....	6V
Input Voltage Range	(-V _S) - 0.3V to (+V _S) + 0.3V
Input Current (All pins except power supply pins).....	±10mA
Output Short-Circuit.....	Continuous
Junction Temperature.....	+150°C
Storage Temperature Range	-65°C to +150°C
Lead Temperature (Soldering, 10s).....	+260°C
ESD Susceptibility	
HBM.....	5000V
CDM	1000V

RECOMMENDED OPERATING CONDITIONS

Supply Voltage Range	2.2V to 5.5V
Operating Temperature Range	-40°C to +125°C

OVERSTRESS CAUTION

Stresses beyond those listed in Absolute Maximum Ratings may cause permanent damage to the device. Exposure to absolute maximum rating conditions for extended periods may affect reliability. Functional operation of the device at any conditions beyond those indicated in the Recommended Operating Conditions section is not implied.

ESD SENSITIVITY CAUTION

This integrated circuit can be damaged if ESD protections are not considered carefully. SGMICRO recommends that all integrated circuits be handled with appropriate precautions. Failure to observe proper handling and installation procedures

can cause damage. ESD damage can range from subtle performance degradation to complete device failure. Precision integrated circuits may be more susceptible to damage because even small parametric changes could cause the device not to meet the published specifications.

DISCLAIMER

SG Micro Corp reserves the right to make any change in circuit design, or specifications without prior notice.

PIN CONFIGURATIONS

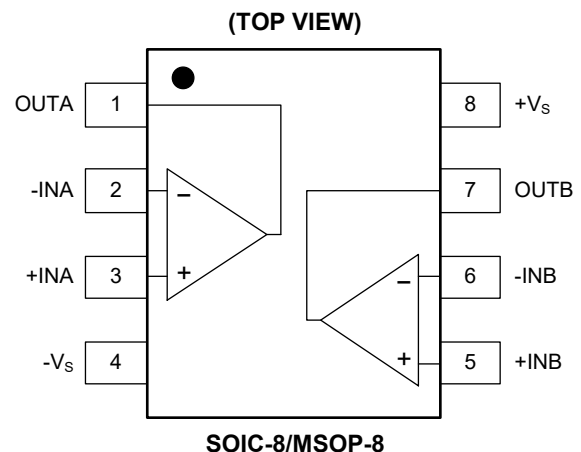

50MHz, Low Distortion, Rail-to-Rail I/O, SGM8965A-2Q Single-Supply, Automotive Operational Amplifier

ELECTRICAL CHARACTERISTICS

($V_S = 2.2V$ to $5.5V$, $V_{CM} = V_S/2$, $V_{OUT} = V_S/2$ and $R_L = 10k\Omega$ connected to $V_S/2$, Full = $-40^\circ C$ to $+125^\circ C$, typical values are at $T_A = +25^\circ C$, unless otherwise noted.)

PARAMETER	CONDITIONS	TEMP	MIN	TYP	MAX	UNITS
Input Characteristics						
Input Offset Voltage (V_{OS})		+25°C		50	280	μV
		Full			1000	
Input Offset Voltage Drift ($\Delta V_{OS}/\Delta T$)		Full		2.2	8	$\mu V/^\circ C$
Input Bias Current (I_b)		Full		1	2800	pA
Input Offset Current (I_{OS})		Full		1	400	pA
Input Common Mode Voltage Range (V_{CM})		Full	$(-V_S) - 0.1$		$(+V_S) + 0.1$	V
Common Mode Rejection Ratio (CMRR)	$(-V_S) - 0.1V \leq V_{CM} \leq (+V_S) + 0.1V$	+25°C	76	94		dB
		Full	64			
Open-Loop Voltage Gain (A_{OL})	$250mV < V_{OUT} < (+V_S) - 250mV$, $R_L = 600\Omega$	+25°C	91	118		dB
		Full	88			
	$100mV < V_{OUT} < (+V_S) - 100mV$, $R_L = 10k\Omega$	+25°C	92	118		
		Full	89			
Output Characteristics						
Output Voltage Swing from Rail	$V_S = 5.5V$	Full		6	12	mV
Output Short-Circuit Current (I_{SC})	$V_S = 5.5V$	Full	55	80		mA
Open-Loop Output Impedance	$f = 1MHz$, $I_{OUT} = 0A$	+25°C		30		Ω
Power Supply						
Specified Voltage Range (V_S)		Full	2.2		5.5	V
Quiescent Current (I_Q)	$I_{OUT} = 0A$	+25°C		10	13	mA
		Full			13.4	
Power Supply Rejection Ratio (PSRR)		Full		4	70	$\mu V/V$
Dynamic Performance						
Gain-Bandwidth Product (GBP)	$C_L = 10pF$	+25°C		50		MHz
Phase Margin (ϕ_O)	$C_L = 10pF$	+25°C		55		°
Slew Rate (SR)	$G = +1$	+25°C		28		V/ μs
Settling Time to 0.1%	4V step, $G = -1$	+25°C		380		ns
Settling Time to 0.01%	4V step, $G = -1$	+25°C		520		ns
Overload Recovery Time	$V_{IN} \times G > V_S$	+25°C		< 0.1		μs
Total Harmonic Distortion + Noise (THD+N)	$V_{OUT} = 4V_{P-P}$, $G = +1$, $f = 1kHz$, $R_L = 600\Omega$	+25°C		0.0002		%
Noise						
Input Voltage Noise	$f = 0.1Hz$ to $10Hz$	+25°C		9.5		μV_{P-P}
Input Voltage Noise Density (e_n)	$f = 100kHz$	+25°C		5.5		nV/ \sqrt{Hz}
Input Current Noise Density (i_n)	$f = 10kHz$	+25°C		20		fA/ \sqrt{Hz}

50MHz, Low Distortion, Rail-to-Rail I/O, SGM8965A-2Q Single-Supply, Automotive Operational Amplifier

TYPICAL PERFORMANCE CHARACTERISTICS

At $T_A = +25^\circ\text{C}$, $V_S = 5\text{V}$, $V_{CM} = V_S/2$, unless otherwise noted.

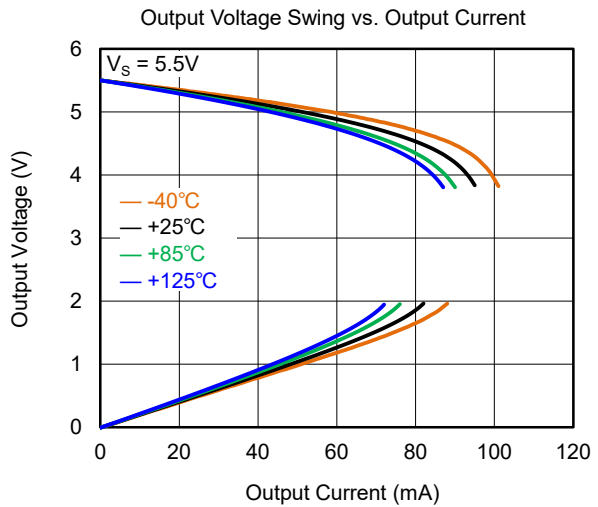
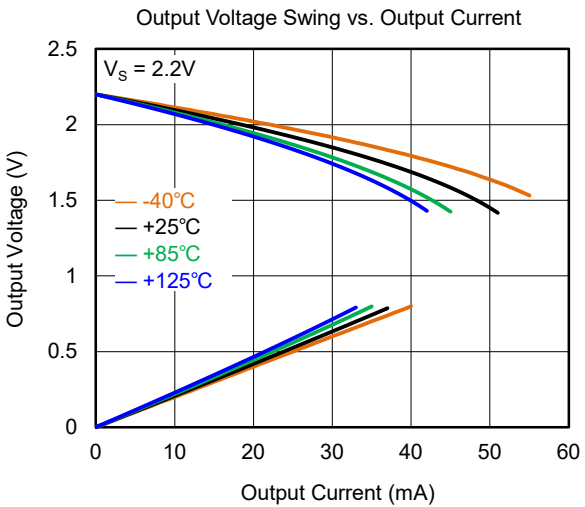
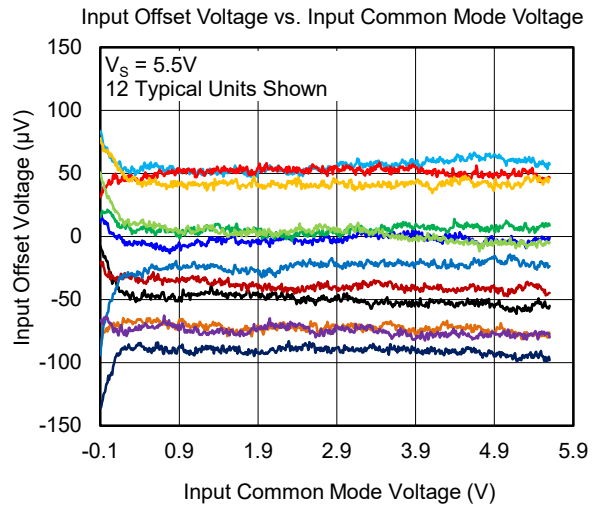
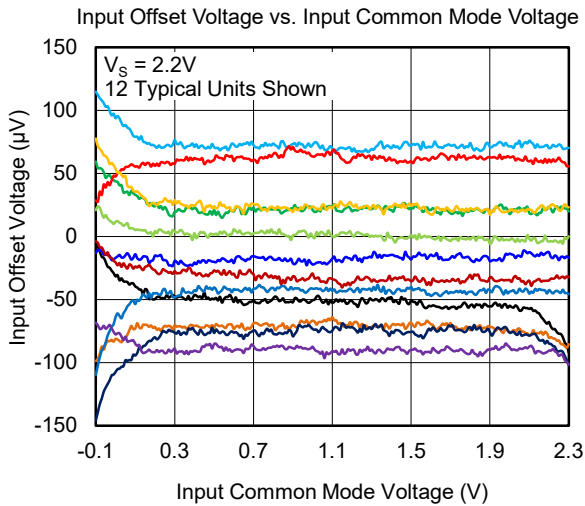
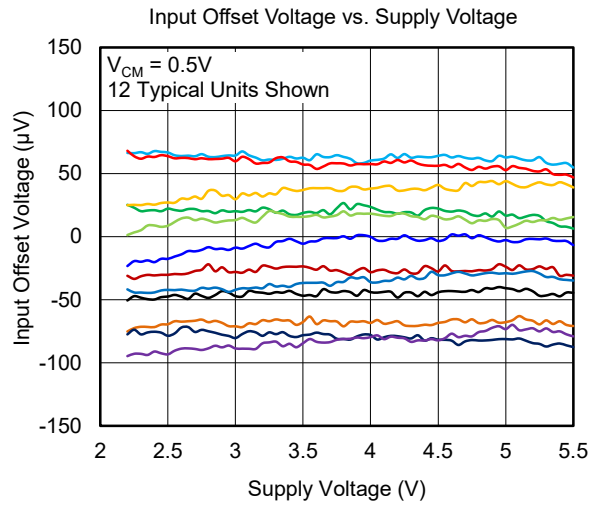
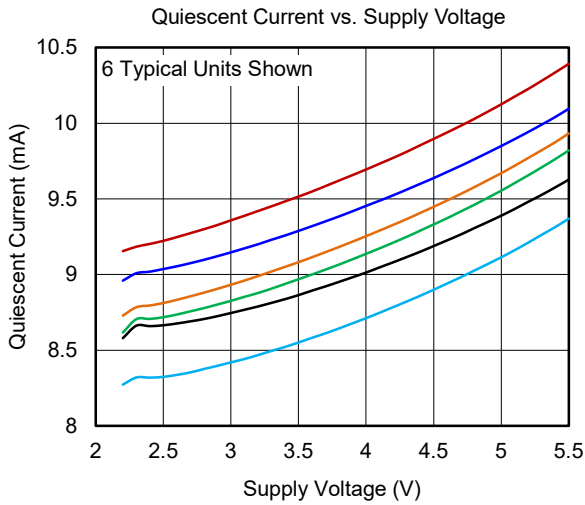

SGM8965A-2Q 50MHz, Low Distortion, Rail-to-Rail I/O, Single-Supply, Automotive Operational Amplifier

TYPICAL PERFORMANCE CHARACTERISTICS (continued)

At $T_A = +25^\circ\text{C}$, $V_S = 5\text{V}$, $V_{CM} = V_S/2$, unless otherwise noted.

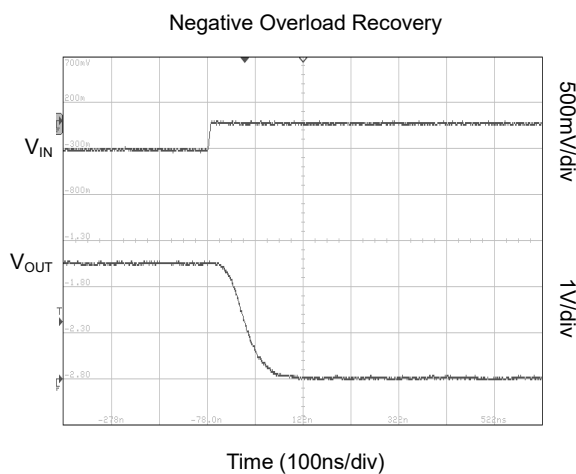
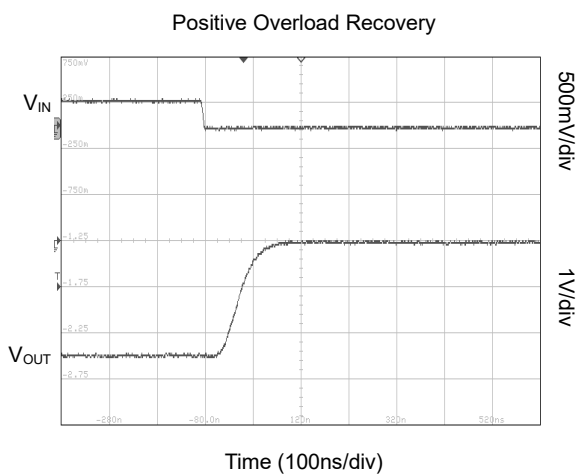
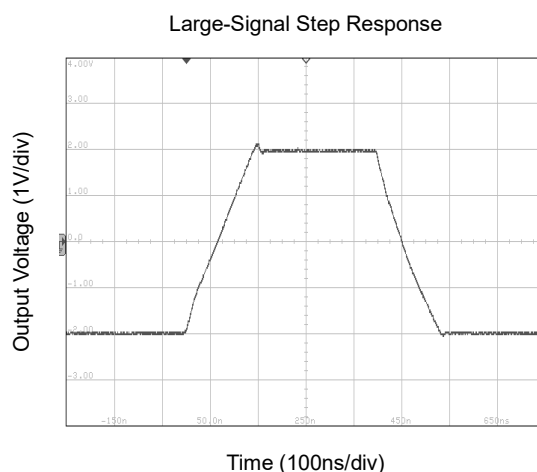
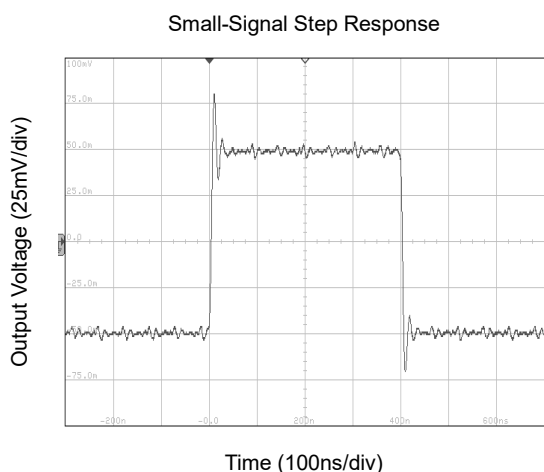
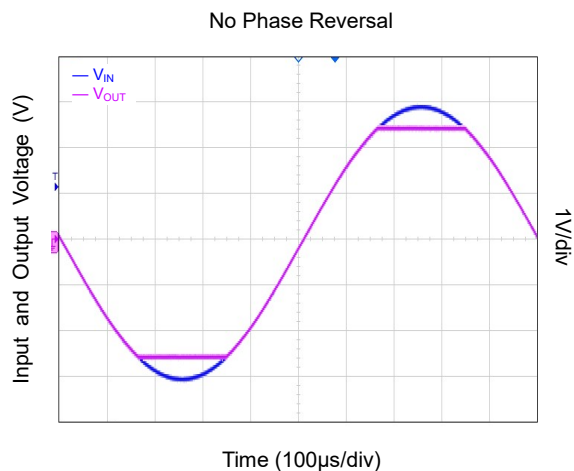
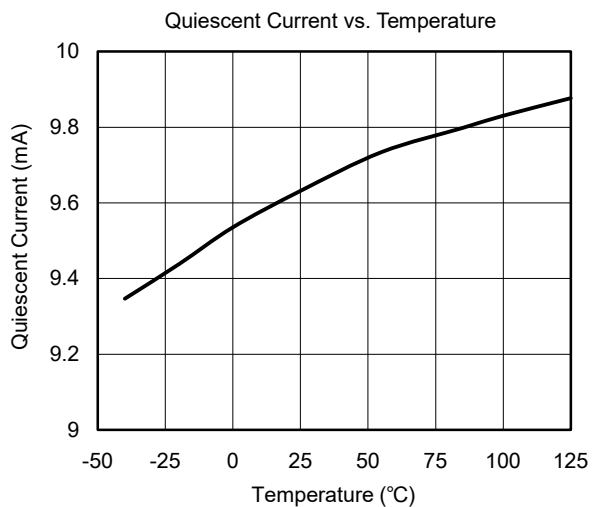

50MHz, Low Distortion, Rail-to-Rail I/O, SGM8965A-2Q Single-Supply, Automotive Operational Amplifier

TYPICAL PERFORMANCE CHARACTERISTICS (continued)

At $T_A = +25^\circ\text{C}$, $V_S = 5\text{V}$, $V_{CM} = V_S/2$, unless otherwise noted.

0.1Hz to 10Hz Input Voltage Noise

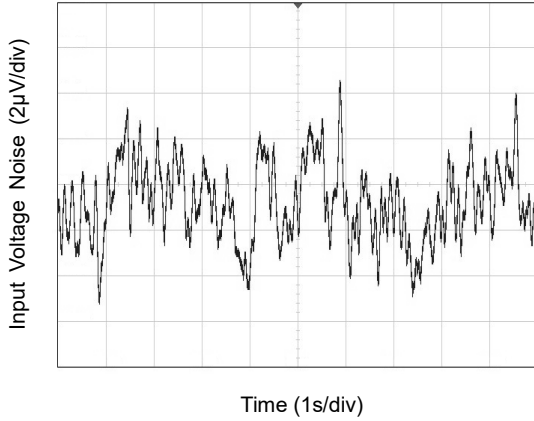

Input Voltage Noise Density vs. Frequency

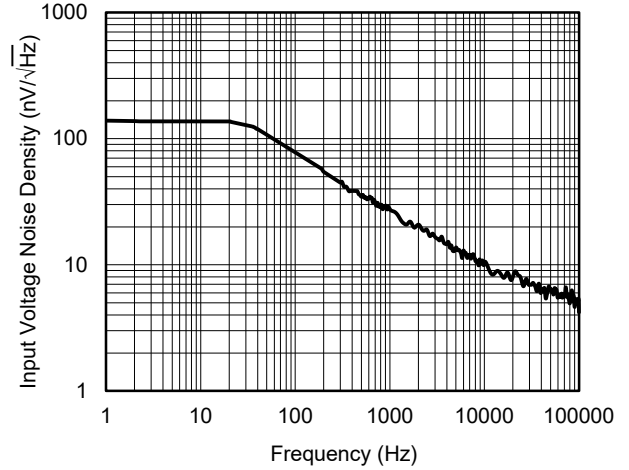

CMRR vs. Frequency (Referred-to-Input)

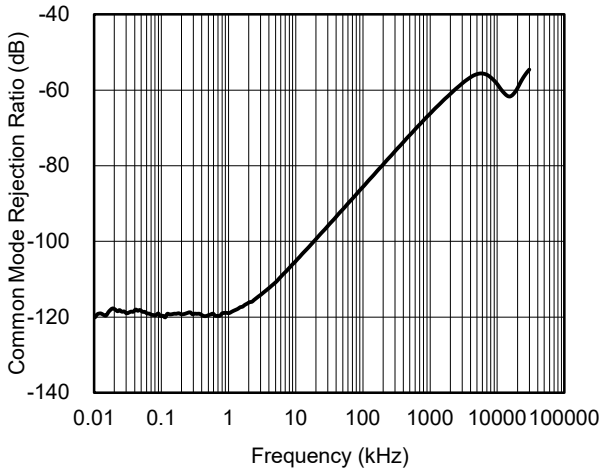

PSRR vs. Frequency (Referred-to-Input)

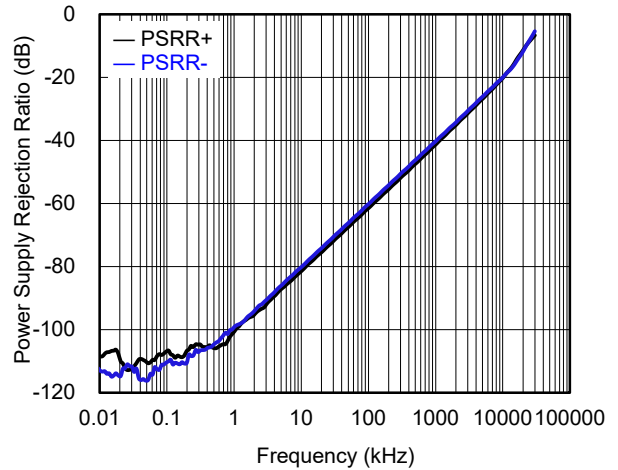

Maximum Output Voltage vs. Frequency

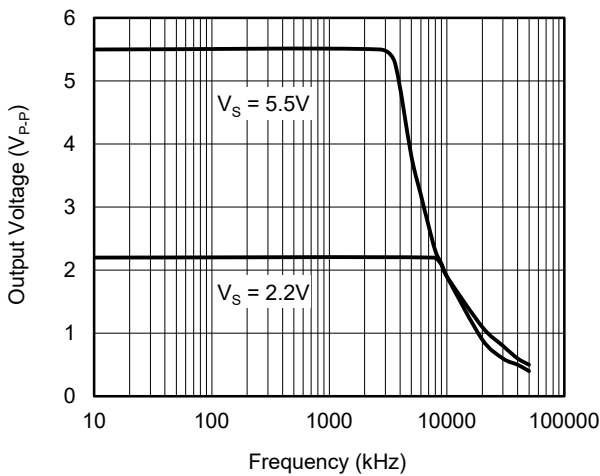

Open-Loop Gain and Phase vs. Frequency

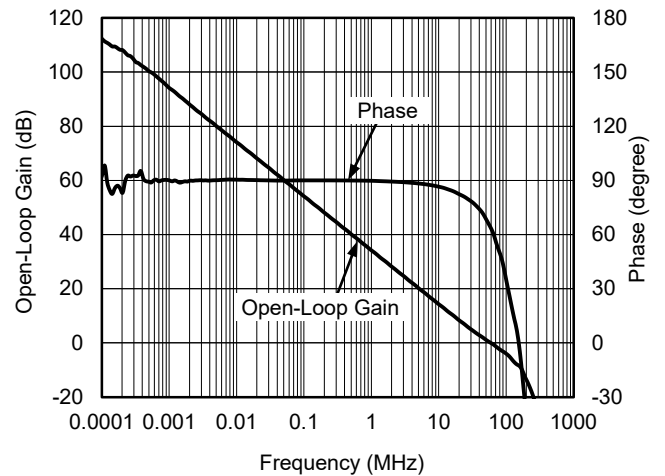

50MHz, Low Distortion, Rail-to-Rail I/O, SGM8965A-2Q Single-Supply, Automotive Operational Amplifier

TYPICAL PERFORMANCE CHARACTERISTICS (continued)

At $T_A = +25^\circ\text{C}$, $V_S = 5\text{V}$, $V_{CM} = V_S/2$, unless otherwise noted.

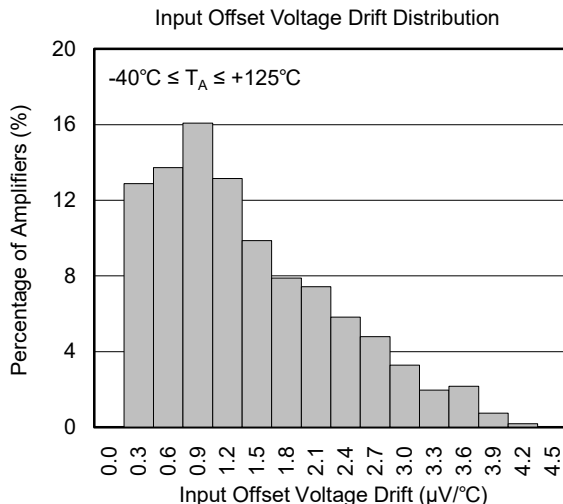
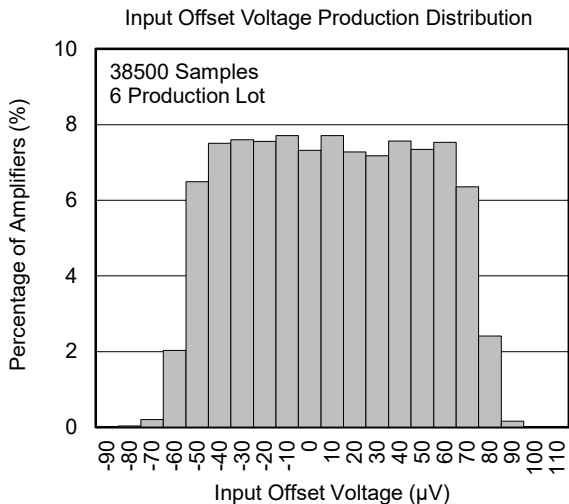
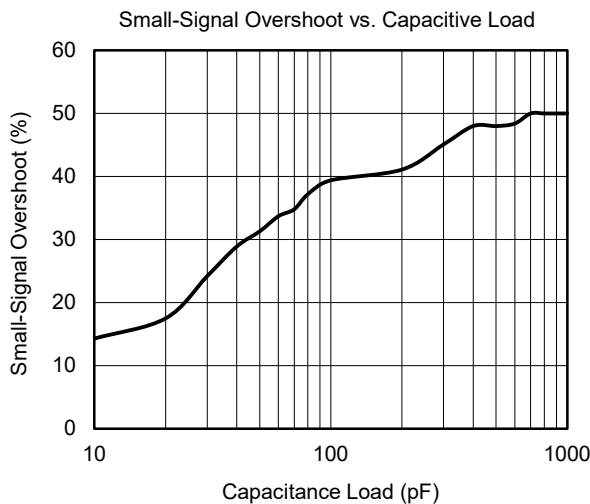
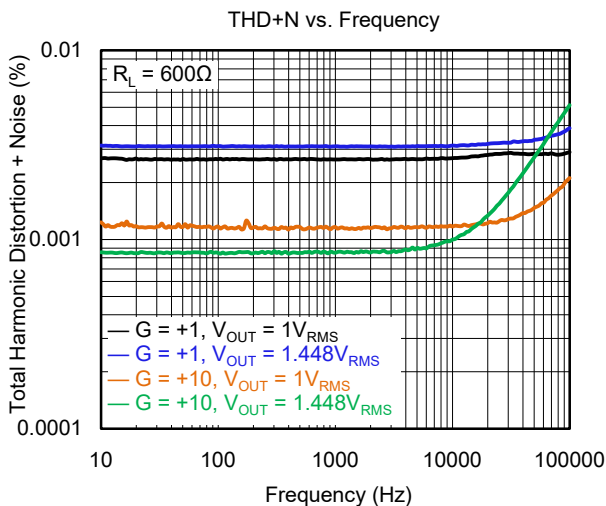
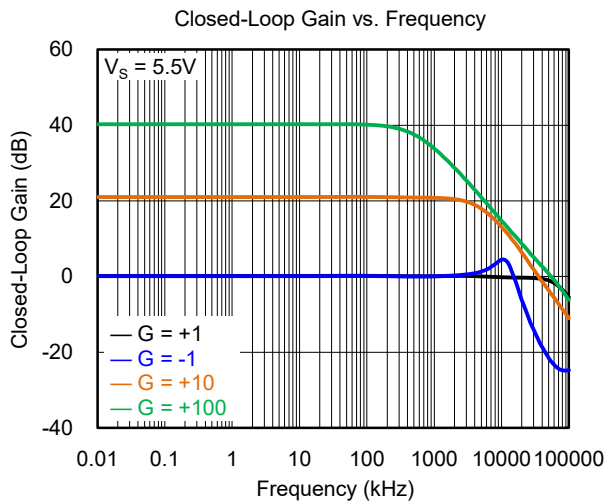
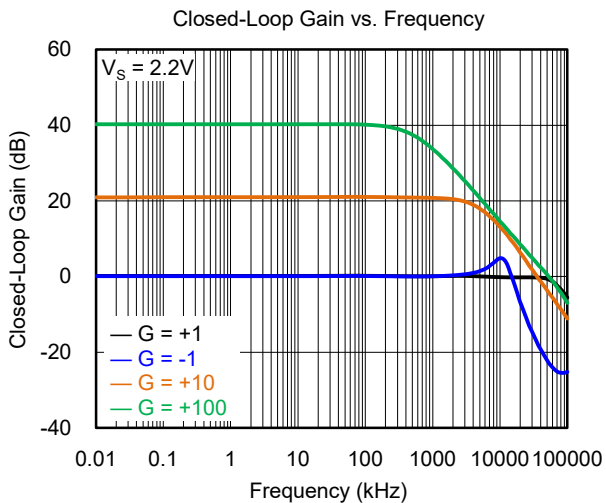

SGM8965A-2Q 50MHz, Low Distortion, Rail-to-Rail I/O, Single-Supply, Automotive Operational Amplifier

APPLICATION INFORMATION

Basic Connection

The SGM8965A-2Q can operate on single supply or dual power supplies, as shown in Figure 1. This device is designed to be a basic inverting amplifier, whose gain is $-10V/V$. For single-supply operation, the output voltage takes input common mode voltage (V_{CM}) as the

center voltage, which is 1.5V as shown in the following circuit connection. Moreover, the input common mode voltage (V_{CM}) is from $(-V_S) - 0.1V$ to $(+V_S) + 0.1V$, and the output voltage can be any value in this range. For dual-supply operation, the output voltage takes 0V as the center voltage.

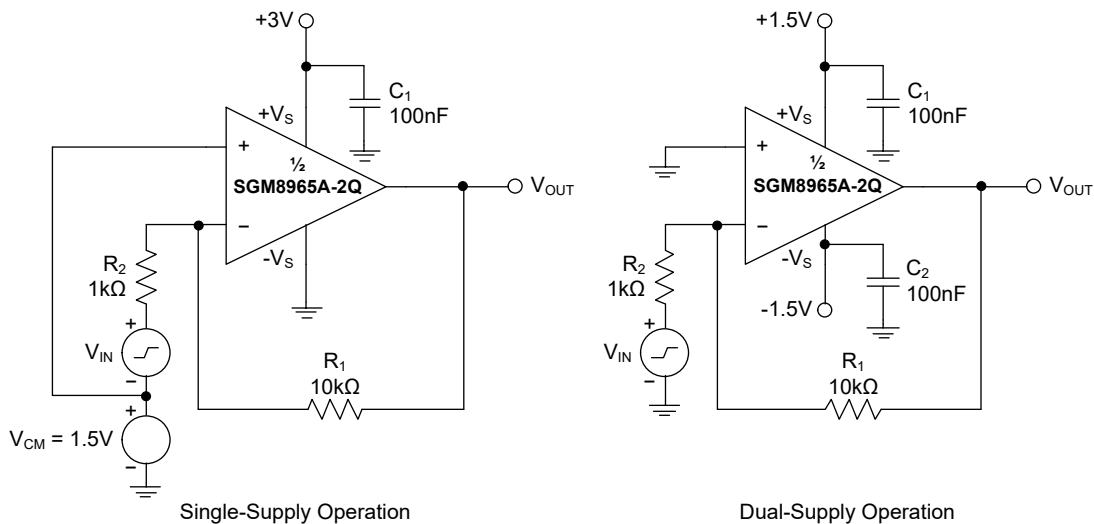

Figure 1. Basic Connections

SGM8965A-2Q **50MHz, Low Distortion, Rail-to-Rail I/O,
Single-Supply, Automotive Operational Amplifier**

REVISION HISTORY

NOTE: Page numbers for previous revisions may differ from page numbers in the current version.

Changes from Original (DECEMBER 2023) to REV.A	Page
Changed from product preview to production data.....	All

PACKAGE OUTLINE DIMENSIONS

SOIC-8

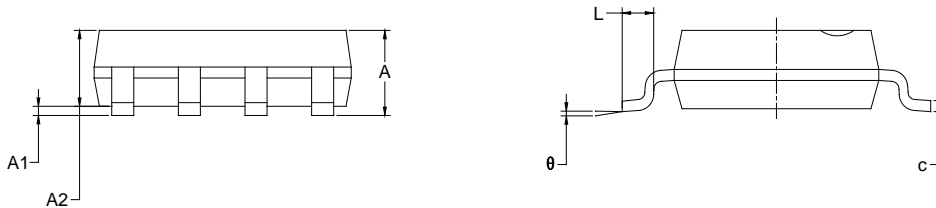
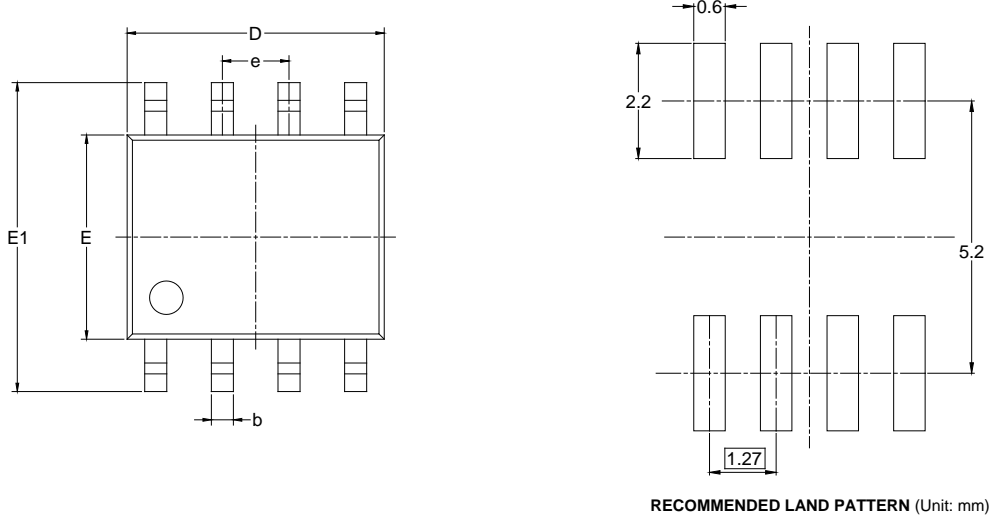

Symbol	Dimensions In Millimeters		Dimensions In Inches	
	MIN	MAX	MIN	MAX
A	1.350	1.750	0.053	0.069
A1	0.100	0.250	0.004	0.010
A2	1.350	1.550	0.053	0.061
b	0.330	0.510	0.013	0.020
c	0.170	0.250	0.006	0.010
D	4.700	5.100	0.185	0.200
E	3.800	4.000	0.150	0.157
E1	5.800	6.200	0.228	0.244
e	1.27 BSC		0.050 BSC	
L	0.400	1.270	0.016	0.050
θ	0°	8°	0°	8°

NOTES:
 1. Body dimensions do not include mode flash or protrusion.
 2. This drawing is subject to change without notice.

PACKAGE OUTLINE DIMENSIONS

MSOP-8

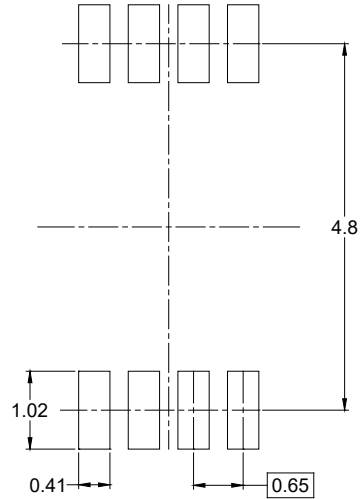
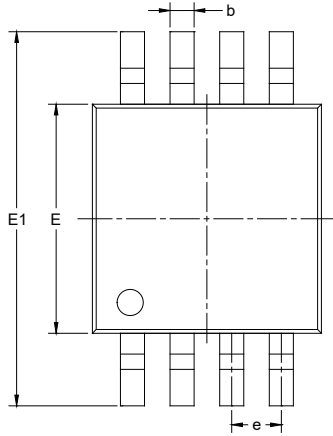

RECOMMENDED LAND PATTERN (Unit: mm)

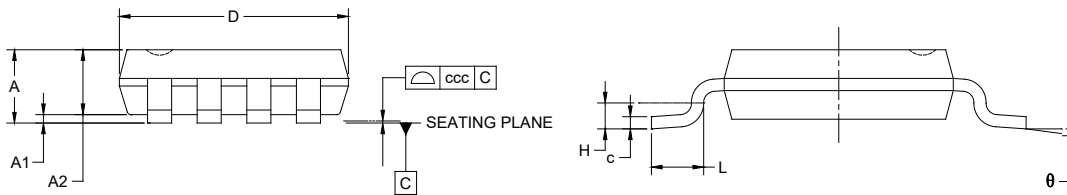

Symbol	Dimensions In Millimeters		
	MIN	MOD	MAX
A	-	-	1.100
A1	0.000	-	0.150
A2	0.750	-	0.950
b	0.220	-	0.380
c	0.080	-	0.230
D	2.800	-	3.200
E	2.800	-	3.200
E1	4.650	-	5.150
e	0.650 BSC		
L	0.400	-	0.800
H	0.250 TYP		
θ	0°	-	8°
ccc	0.100		

NOTES:

1. This drawing is subject to change without notice.
2. The dimensions do not include mold flashes, protrusions or gate burrs.
3. Reference JEDEC MO-187.

TAPE AND REEL INFORMATION

REEL DIMENSIONS



TAPE DIMENSIONS



NOTE: The picture is only for reference. Please make the object as the standard.

KEY PARAMETER LIST OF TAPE AND REEL

Package Type	Reel Diameter	Reel Width W1 (mm)	A0 (mm)	B0 (mm)	K0 (mm)	P0 (mm)	P1 (mm)	P2 (mm)	W (mm)	Pin1 Quadrant
SOIC-8	13"	12.4	6.40	5.40	2.10	4.0	8.0	2.0	12.0	Q1
MSOP-8	13"	12.4	5.20	3.30	1.50	4.0	8.0	2.0	12.0	Q1

DD0001

PACKAGE INFORMATION

CARTON BOX DIMENSIONS



NOTE: The picture is only for reference. Please make the object as the standard.

KEY PARAMETER LIST OF CARTON BOX

Reel Type	Length (mm)	Width (mm)	Height (mm)	Pizza/Carton
13"	386	280	370	5

DD0002