

GENERAL DESCRIPTION

The SGM9154 is a 1-channel, 6th-order output reconstruction filter which can operate from 3.1V to 5.5V single power supply. It is designed to replace passive LC filters and drivers with an integrated device. One channel is High Definition (HDp) filter.

The device allows DC- or AC-coupled output. SGM9154 can be DC-coupled or AC-coupled with input video signal to eliminate out-of-band noise, such as the output stage of DAC. Internal bias circuitry may be used for providing constant bias voltage if AC-coupled inputs are required.

The SGM9154 is available in Green TSSOP-8 and SOT-23-6 and SC70-5 packages. It operates over an ambient temperature range of -40°C to +85°C.

FEATURES

- **Supply Voltage Range: 3.1V to 5.5V**
- **One 6th-Order 1080p High Definition Filter**
- **Bias Mode Active with AC-Coupled Inputs**
- **Bias Mode Inactive with DC-Coupled Inputs**
- **AC- or DC-Coupled Output**
- **DC-Coupled Outputs Eliminate AC-Coupled Capacitors**
- **-40°C to +85°C Operating Temperature Range**
- **Available in Green TSSOP-8 and SOT-23-6 and SC70-5 Packages**

APPLICATIONS

- Video Recorders
- Video on Demand (VOD)
- Cable and Satellite Set-Top Boxes
- Portable and Handheld Products
- Communication Devices
- TVs

BLOCK DIAGRAM

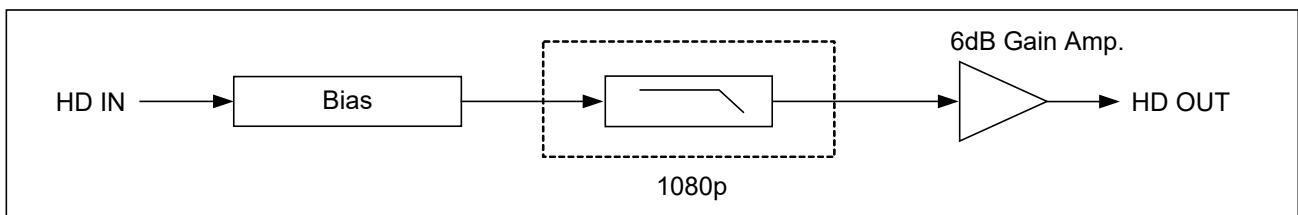

PACKAGE/ORDERING INFORMATION

MODEL	PACKAGE DESCRIPTION	SPECIFIED TEMPERATURE RANGE	ORDERING NUMBER	PACKAGE MARKING	PACKING OPTION
SGM9154A (6dB Gain)	TSSOP-8	-40°C to +85°C	SGM9154AYTS8G/TR	SZ8 YTS8 XXXXX	Tape and Reel, 4000
	SOT-23-6	-40°C to +85°C	SGM9154AYN6G/TR	SZ4XX	Tape and Reel, 3000
	SC70-5	-40°C to +85°C	SGM9154AYC5G/TR	SZ5XX	Tape and Reel, 3000

MARKING INFORMATION

NOTE: XX = Date Code. XXXXX = Date Code and Vendor Code.

TSSOP-8

XXXXX

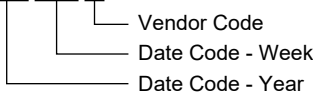

SOT-23-6/ SC70-5

YYY X X

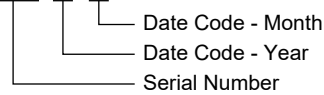

Green (RoHS & HSF): SG Micro Corp defines "Green" to mean Pb-Free (RoHS compatible) and free of halogen substances. If you have additional comments or questions, please contact your SGMICRO representative directly.

- Input Voltage..... GND - 0.3V to V_{CC} + 0.3V
- Supply Voltage, V_{CC}..... 6.0V
- Junction Temperature +150°C
- Storage Temperature Range..... -65°C to +150°C
- Lead Temperature (Soldering, 10s) +260°C
- ESD Susceptibility
- HBM..... 8000V
- MM..... 400V

RECOMMENDED OPERATING CONDITIONS

- Operating Voltage Range..... 3.1V to 5.5V
- Operating Temperature Range -40°C to +85°C

OVERSTRESS CAUTION

Stresses beyond those listed in Absolute Maximum Ratings may cause permanent damage to the device. Exposure to absolute maximum rating conditions for extended periods may affect reliability. Functional operation of the device at any conditions beyond those indicated in the Recommended Operating Conditions section is not implied.

ESD SENSITIVITY CAUTION

This integrated circuit can be damaged if ESD protections are not considered carefully. SGMICRO recommends that all integrated circuits be handled with appropriate precautions. Failure to observe proper handling and installation procedures can cause damage. ESD damage can range from subtle performance degradation to complete device failure. Precision integrated circuits may be more susceptible to damage because even small parametric changes could cause the device not to meet the published specifications.

DISCLAIMER

SG Micro Corp reserves the right to make any change in circuit design, or specifications without prior notice.

PIN CONFIGURATIONS

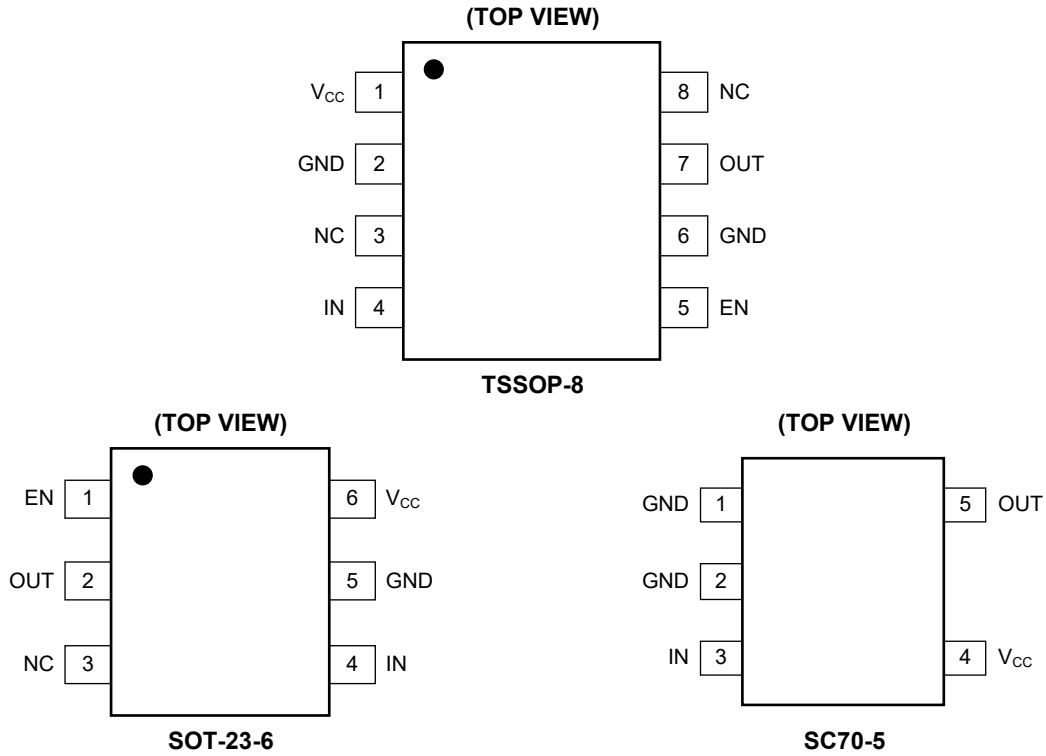

PIN DESCRIPTION

PIN			NAME	FUNCTION
TSSOP-8	SOT-23-6	SC70-5		
1	6	4	V _{CC}	Power Supply.
2, 6	5	1, 2	GND	Ground.
3, 8	3	—	NC	No Internal Connection.
4	4	3	IN	Video Input.
5	1	—	EN	Enable Pin.
7	2	5	OUT	Video Output.

ELECTRICAL CHARACTERISTICS

($V_{CC} = 5V$, SGM9154A $V_{IN} = 1V_{PP}$, $T_A = +25^\circ C$, $R_{SOURCE} = 37.5\Omega$; the input is AC-coupled with $0.1\mu F$; the output is AC-coupled with $220\mu F$ into 150Ω , referenced to 400kHz, unless otherwise noted.)

PARAMETER	CONDITIONS	MIN	TYP	MAX	UNITS
DC Electrical Characteristics					
Operating Voltage Range (V_{CC})		3.1	5	5.5	V
Quiescent Current (I_Q)	No load		15	20	mA
Output Level Shift Voltage (V_{OLS})	$V_{IN} = 0V$, no load		350	530	mV
Voltage Gain of SGM9154A (A_V)	$R_L = 150\Omega$	5.75	6.1	6.35	dB
Output Voltage High Swing	$V_{IN} = 3V$, $R_L = 150\Omega$ to GND		4.8		V
Shutdown Current			1.3	15	μA
Video Input Voltage Range	Referenced to GND if DC-coupled		1.4		V_{PP}
Power Supply Rejection Ratio (PSRR)	DC		52		dB
V_{IH} of EN Pin		2.4			V
V_{IL} of EN Pin				0.8	V
1080p High Definition Mode Electrical Characteristics					
Channel Gain	Active video input range = $1V_{PP}$		6		dB
-1dB Bandwidth of SGM9154A	$R_L = 150\Omega$		70		MHz
-3dB Bandwidth of SGM9154A	$R_L = 150\Omega$		79		MHz
Filter Response (Normalized Gain)	$f_{IN} = 400kHz$ to 148MHz		26.5		dB
Group Delay Variation (D/DT)	Difference between 400kHz and 70MHz		3.5		ns
Slew Rate	2V output step, 80% to 20%		300		$V/\mu s$
Fall Time	2V output step, 80% to 20%		4		ns
Rise Time	2V output step, 80% to 20%		4		ns
Signal to Noise Ratio (SNR)	100kHz to 70MHz		-63		dB
Enable Time (t_{ON})			1.2		μs
Disable Time (t_{OFF})			0.4		μs

TYPICAL PERFORMANCE CHARACTERISTICS

$V_{CC} = 5V$, SGM9154A $V_{IN} = 1V_{PP}$, $T_A = +25^{\circ}C$, $R_{SOURCE} = 37.5\Omega$; the input is AC-coupled with $0.1\mu F$; the output is AC-coupled with $220\mu F$ into 150Ω , referenced to $400kHz$, unless otherwise noted.

Gain vs. Frequency

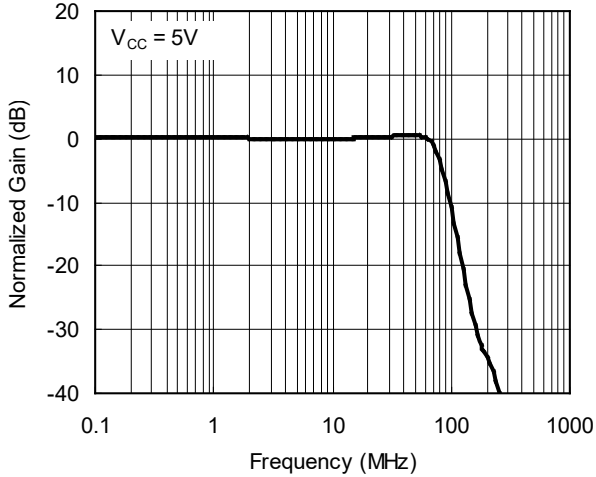

Group Delay vs. Frequency

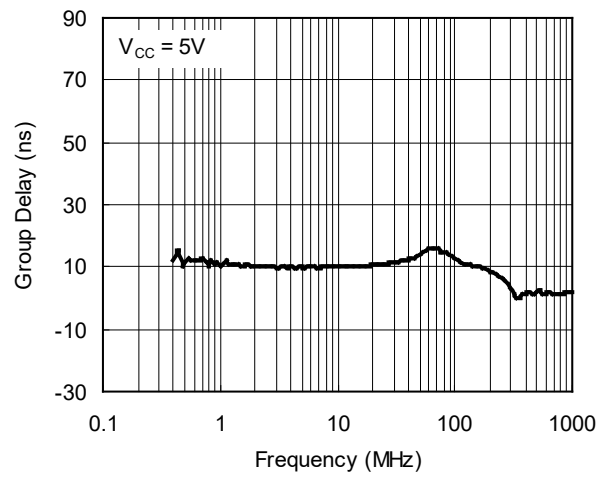

Large Signal Step Response

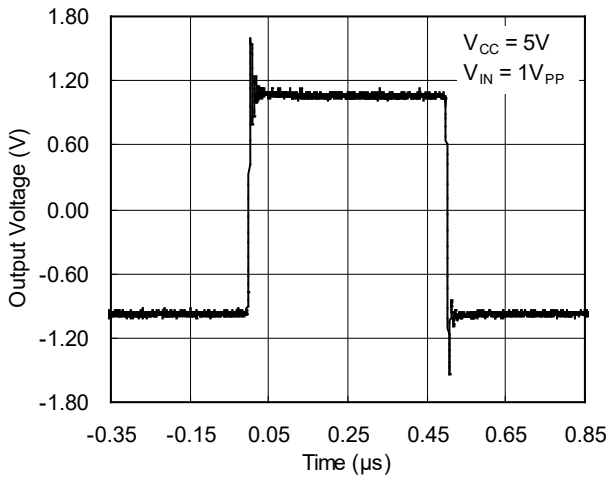

Small Signal Step Response

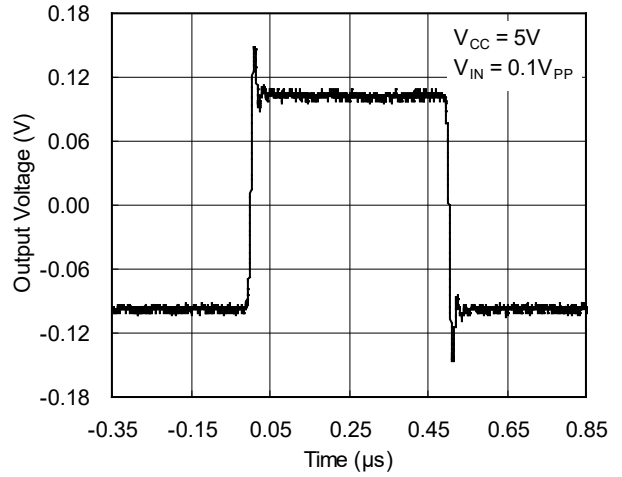

REVISION HISTORY

NOTE: Page numbers for previous revisions may differ from page numbers in the current version.

MAY 2023 – REV.A to REV.A.1	Page
Updated Package Outline Dimensions section	9

Changes from Original (APRIL 2015) to REV.A	Page
Changed from product preview to production data.....	All

PACKAGE OUTLINE DIMENSIONS

TSSOP-8

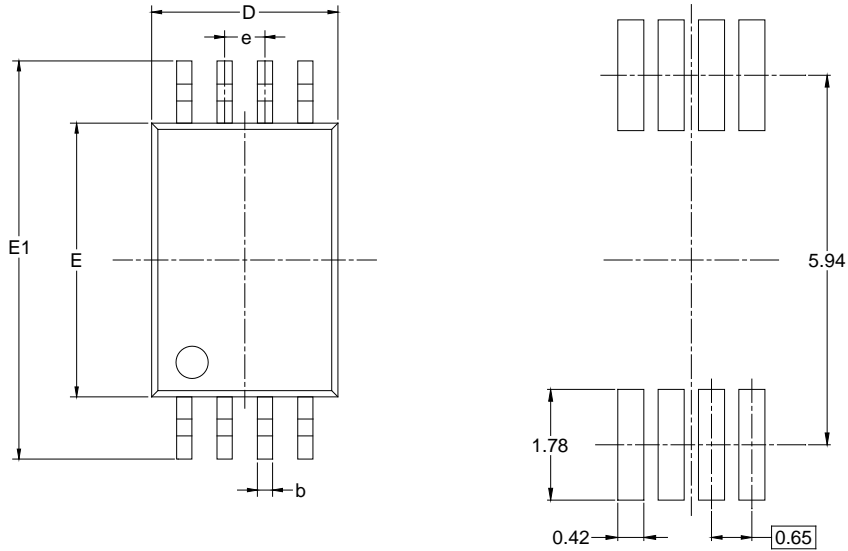

RECOMMENDED LAND PATTERN (Unit: mm)

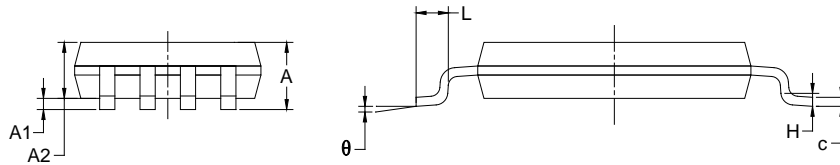

Symbol	Dimensions In Millimeters		Dimensions In Inches	
	MIN	MAX	MIN	MAX
A		1.100		0.043
A1	0.050	0.150	0.002	0.006
A2	0.800	1.000	0.031	0.039
b	0.190	0.300	0.007	0.012
c	0.090	0.200	0.004	0.008
D	2.900	3.100	0.114	0.122
E	4.300	4.500	0.169	0.177
E1	6.250	6.550	0.246	0.258
e	0.650 BSC		0.026 BSC	
L	0.500	0.700	0.02	0.028
H	0.25 TYP		0.01 TYP	
θ	1°	7°	1°	7°

NOTES:

1. Body dimensions do not include mode flash or protrusion.
2. This drawing is subject to change without notice.

PACKAGE OUTLINE DIMENSIONS

SOT-23-6

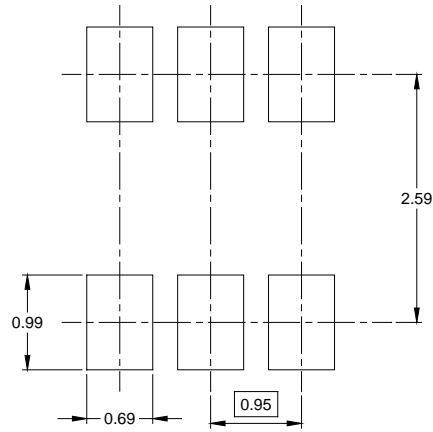
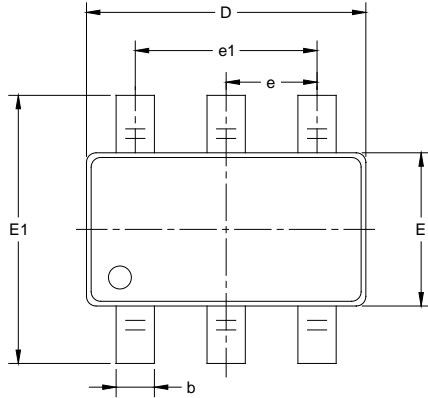

RECOMMENDED LAND PATTERN (Unit: mm)

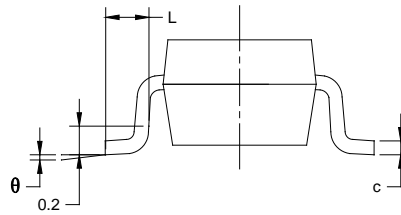
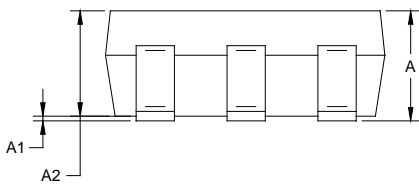

Symbol	Dimensions In Millimeters		Dimensions In Inches	
	MIN	MAX	MIN	MAX
A	1.050	1.250	0.041	0.049
A1	0.000	0.100	0.000	0.004
A2	1.050	1.150	0.041	0.045
b	0.300	0.500	0.012	0.020
c	0.100	0.200	0.004	0.008
D	2.820	3.020	0.111	0.119
E	1.500	1.700	0.059	0.067
E1	2.650	2.950	0.104	0.116
e	0.950 BSC		0.037 BSC	
e1	1.900 BSC		0.075 BSC	
L	0.300	0.600	0.012	0.024
θ	0°	8°	0°	8°

NOTES:

1. Body dimensions do not include mode flash or protrusion.
2. This drawing is subject to change without notice.

PACKAGE OUTLINE DIMENSIONS

SC70-5

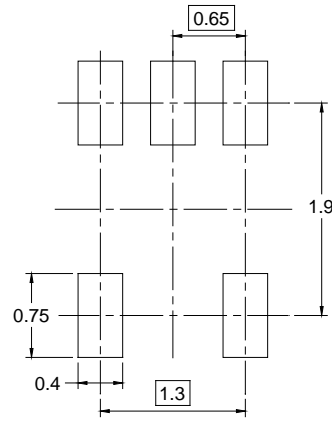
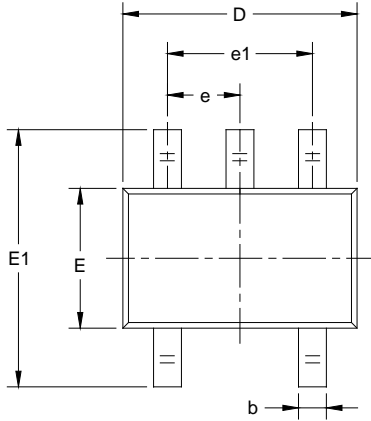

RECOMMENDED LAND PATTERN (Unit: mm)

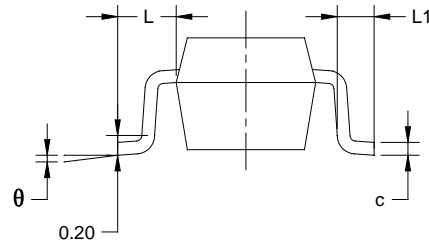
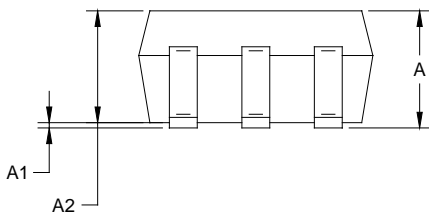

Symbol	Dimensions In Millimeters		Dimensions In Inches	
	MIN	MAX	MIN	MAX
A	0.800	1.100	0.031	0.043
A1	0.000	0.100	0.000	0.004
A2	0.800	1.000	0.031	0.039
b	0.150	0.350	0.006	0.014
c	0.080	0.220	0.003	0.009
D	2.000	2.200	0.079	0.087
E	1.150	1.350	0.045	0.053
E1	2.150	2.450	0.085	0.096
e	0.65 TYP		0.026 TYP	
e1	1.300 BSC		0.051 BSC	
L	0.525 REF		0.021 REF	
L1	0.260	0.460	0.010	0.018
θ	0°	8°	0°	8°

NOTES:

1. Body dimensions do not include mode flash or protrusion.
2. This drawing is subject to change without notice.

TAPE AND REEL INFORMATION

REEL DIMENSIONS



TAPE DIMENSIONS



NOTE: The picture is only for reference. Please make the object as the standard.

KEY PARAMETER LIST OF TAPE AND REEL

Package Type	Reel Diameter	Reel Width W1 (mm)	A0 (mm)	B0 (mm)	K0 (mm)	P0 (mm)	P1 (mm)	P2 (mm)	W (mm)	Pin1 Quadrant
TSSOP-8	13"	12.4	6.76	3.30	1.80	4.0	8.0	2.0	12.0	Q1
SOT-23-6	7"	9.5	3.23	3.17	1.37	4.0	4.0	2.0	8.0	Q3
SC70-5	7"	9.5	2.40	2.50	1.20	4.0	4.0	2.0	8.0	Q3

000001

PACKAGE INFORMATION

CARTON BOX DIMENSIONS



NOTE: The picture is only for reference. Please make the object as the standard.

KEY PARAMETER LIST OF CARTON BOX

Reel Type	Length (mm)	Width (mm)	Height (mm)	Pizza/Carton
7" (Option)	368	227	224	8
7"	442	410	224	18
13"	386	280	370	5

DD0002